

INSTRUCTIONS

© 2023, Speedway Motors, Inc.



910-31902 - Non-Emergency Brake

910-31921 - Emergency Brake

KIT CONTENTS	
Qty	Description
2	New Rotors
2	2-Piece Brackets
8	5/16 Spacers (4)
8	1/8 Spacers (2)
8	Spacer Plates
8	3/8-24 x 1-1/2 Grade 8 Bolts
8	3/8-24 x 2 Grade 8 Bolts
16	3/8 Flat Washers
16	3/8 Grade 8 Nuts

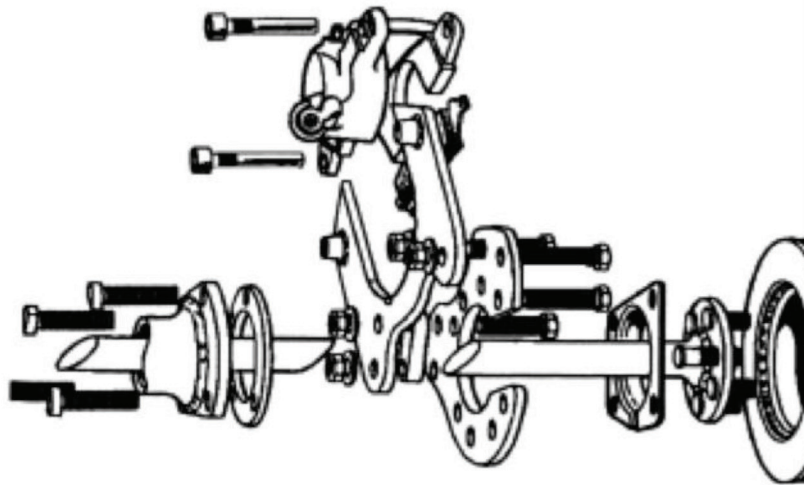

Car Rear Disc Brake Conversion (Pressed Bearing Style)

Replacement and Additional Parts:

1978-83 Chevelle, Monte Carlo, El Camino, Malibu, Tempest, Cutlass, F-85, PontiacmGrand Prix, Le Mans, GTO, Grand Am, Bonneville front calipers (no parking brake) with pads and mounting screws.

1979-85 El Dorado, Riviera, Toronado, 1980-85 Seville with emergency brakes on the calipers. Rear calipers with parking brakes, pads and mounting screws.

Installation Instructions:

1. Installation must begin by taking the axles out of the housing. Start by discarding the factory style T-bolts as they are not long enough to work with this kit. The spacer plate can then be installed on the end using the new supplied 3/8" bolts in the brake kit on the end of the housing as shown. Next, insert the axle and bearing into the housing.

INSTRUCTIONS

© 2023, Speedway Motors, Inc.

SPEEDWAY
motors®



2. Install the base bracket between the spacer and the retainer and secure using the supplied nuts. The ears on the base bracket should be positioned so they will mount the caliper up toward the rear as shown.



3. Make sure to use a quality brake cleaner and rag to clean the anti-corrosion coating off your brake rotors before installing them. This coating can contaminate brake pads.

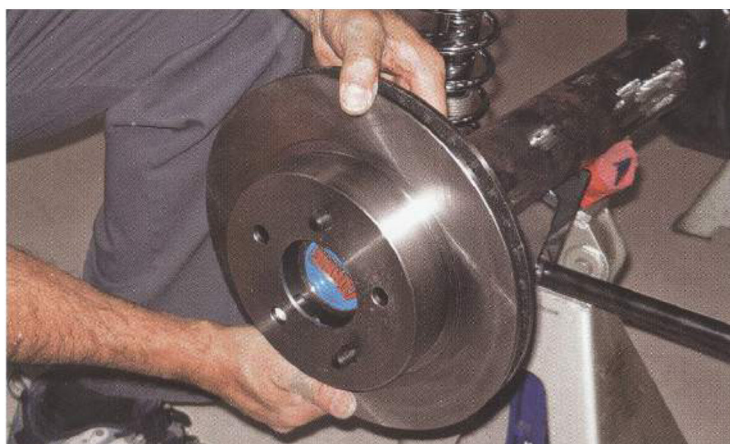

4. Install the rotor over the axle studs and temporarily secure using two hand-tightened lug nuts.

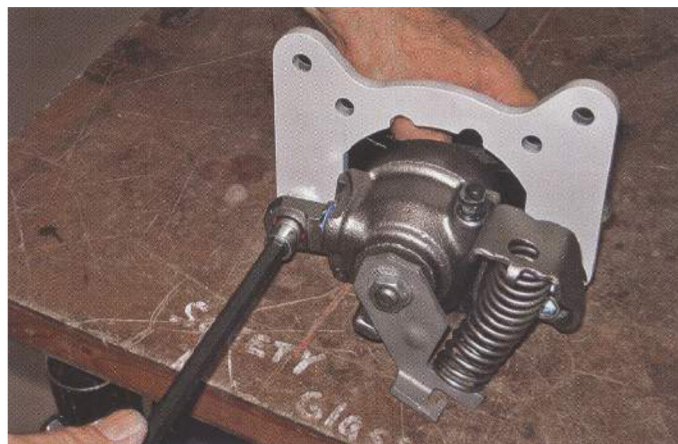

5. Insert the brake pads in the caliper and install the caliper brackets as shown using the supplied Allen-head slider bolts.



6. Test fit the caliper on the rotor, making sure the bleed screw is facing up. Your brake kit comes with bracket spacers in two different thicknesses. Determine the number and thickness of spacers required to properly position the caliper in relation to the rotor.

INSTRUCTIONS

© 2023, Speedway Motors, Inc.

SPEEDWAY
motors®



7. Remove rotor and bolt the caliper bracket to the base bracket using the spacer(s) determined in the previous step.

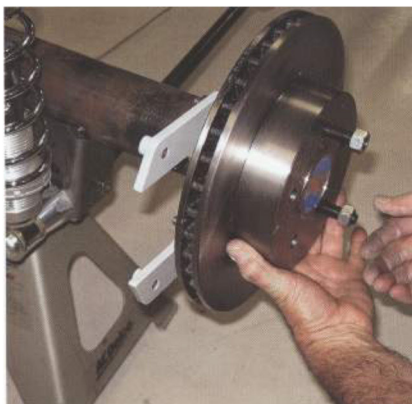

8. Re-install rotor, again using two lug nuts to hold it in place.

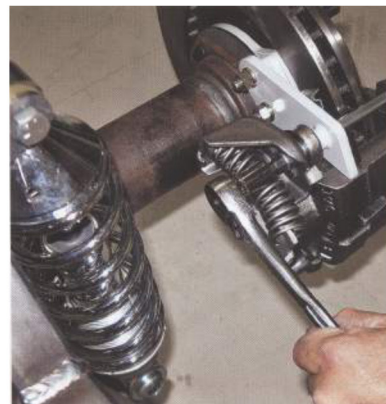

9. Install caliper on bracket using supplied Allen-head slider bolts.

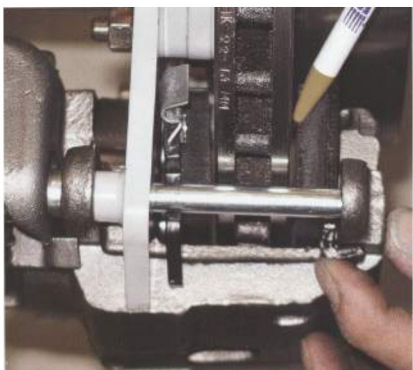

10. With caliper installed, double check to verify the gap between the brake pads and rotors is equal on both sides. Adjust shim packs as needed to achieve equal gap.



11. Since this brake kit uses floating calipers that move with normal brake wear and operation, it is critical to use a flexible brake line between the caliper and axle housing. A tab should be welded to the housing to support the junction between the flex line and hard line.

Adjusting and Bleeding Emergency Brake Calipers

1. When you install the calipers, put them in the position you like. One where the cable will work well (if you have the park brake calipers) and the hose connection is in a good location. If you go off road you can mount the calipers high to avoid brush and rocks. Don't worry about being in the right position to bleed the brakes. The calipers have to be taken off of the brackets to bleed anyway and once they are bled it does not matter what position they are in.

2. Once everything is installed and before you put the wheels on, bleed the calipers. Air rises so the bleed screw must be at the top. You can start with the normal bleeding methods, but the brakes will not work properly and you will have a soft pedal if you do not take the calipers off of the brackets and gravity bleed them to get the last of the air out.

3. To gravity bleed, take the cover off of the master cylinder, take the calipers off of the brackets and hold behind the axle. Hold the caliper so that the bleed screw points forward, horizontal with the ground on the (small) 5-1/2" pin to pin calipers and straight up on the (large) 7" pin to pin calipers. The mounting holes in the ears are around 45° on a non-parking brake caliper and straight up one hole above the other on a parking brake caliper and straight up one hole above the other on a parking brake caliper.

Open the bleed screw and the fluid will start to dribble out. Slowly move the calipers just in case you are not in the correct position and also tap on the calipers with a rubber hammer to knock bubbles loose.

Once the fluid is clear with no air bubbles, close the bleeder and hang that caliper on a wire and do the other side. Do both calipers again and then reinstall. (Do not step on the hydraulic pedal yet.) Go to step 5 for non-parking brake calipers.

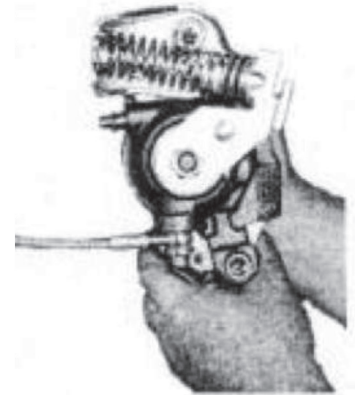

Adjusting and Bleeding Emergency Brake Calipers

4. Adjust the parking brake levers by pushing them forward. Each time you push them they should move off of the stop $3/8"$ to $1/2"$. When released, they should always return to the stop. If they will not adjust, try putting a lever between the rotor and the pad and putting pressure on the piston. Now push the lever releasing pressure on the pad as the caliper adjusts. These are the only two ways we know of to adjust the parking brake. If the calipers won't adjust, you will have a low pedal because the piston will retract too far and will use up all your hydraulic pedal travel to put the brakes on.

Once the parking brake calipers are adjusted, put on a c-clamp between the lever and the bracket to hold the parking brakes locked up.

5. Step on the hydraulic pedal. It should be high and hard. If it is low and spongy or it will pump up, you still have air bubbles. Take the caliper off the brackets and bleed some more.

If you have parking brake calipers and they are locked up against the rotors and there is no air in the rear system, then there will be no fluid movement in the rear brake system and the pedal should be as high as before you changed the brakes and had the parking brake on. It does not matter what size master cylinder you have. If there is no fluid movement you will have a high and hard hydraulic pedal. There might be a problem with your front system since you have a dual braking system. But if you have not changed the front, your pedal should be high and hard.

It is not as easy to check if you are using non-parking brake calipers. The calipers run close to the rotors so check to see that the pads won't rattle. If your pedal is low and spongy, you have air. Take the calipers off and bleed them some more.

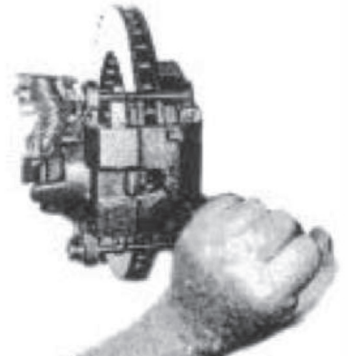
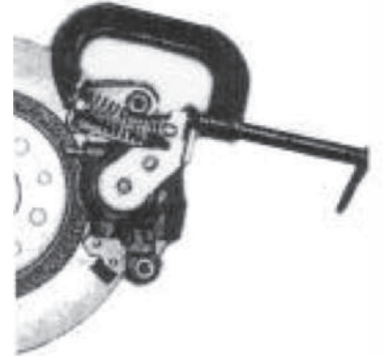

IMPORTANT

DISCLAIMER In an effort to offer our customers low prices, quick service and great value, Speedway Motors reserves the right to change suppliers, specifications, colors, prices, materials without notice. Prices and policies that were current and in effect at the time of printing are also subject to change without notice. Quantities are limited on some items. Any unauthorized use of this catalog including words, photos or drawings is prohibited. Speedway is not responsible for any typographical errors, printing errors or misinterpretations

WARRANTY DISCLAIMER Purchasers understand and recognize that racing parts, specialized street rod equipment, and all other parts and services sold by Speedway Motors, Inc. are exposed to many and varied conditions due to the manner in which they are installed and used. Except for certain limited warranties, if any, set forth in Speedway Motors, Inc.'s current catalog with respect to the products and/or parts thereof identified on your invoice, each product, and each part thereof, is sold "as is", and "with all faults" and Speedway Motors, Inc. makes no warranties either expressed or implied, written or oral, with regard such products and services including, without limitation, any warranty of merchantability or fitness for a particular purpose. Without limiting the foregoing, there is no warranty expressed or implied as to whether the goods sold hereby will protect purchasers or ultimate end-users of such products and parts from injury or death. In no event shall Speedway Motors, Inc. be liable for any special, incidental or consequential damages, or any other damages whatsoever arising out of or connected with the use or misuse of the products and each part thereof. Purchasers acknowledge and agree that no person, entity or agent of Speedway Motors, Inc. has any authority to make any statement contrary to this disclaimer and that any warranty statements or representations allegedly made on behalf of Speedway Motors, Inc. by any such person, entity or agent are void. Purchasers are relying solely on their own skill and judgment to select, purchase and use suitable products and assume all responsibility and risk with regard thereto. Some local laws prohibit the use of utility jugs, funnels and barrel pumps for dispensing fuel. Please check your own state for more information, regulations or further direction in your use of the utility jugs, funnels and barrel pump described in Speedway's catalogs or on Speedway Motors websites. Some parts in this catalog are not legal for sale or use in California. Items sold in this catalog are for racing vehicles which may never be used on a highway. The use of manufacturer's names and symbols are for reference purposes only.

DAMAGE CLAIMS Please inspect all packages upon delivery and in the presence of the delivery driver when possible. The driver must note any visible damage and provide procedures for handling damage claims. To allow for a claims process, please retain original box, packing material and damaged merchandise. Contact Speedway Motors for instructions regarding damage claim within 5 days of receipt. Speedway Motors assumes no liability after this period.

SHORTAGES Please check the contents of your delivery to ensure that all parts ordered are received. Refer to your invoice to cross check all items received and inspect all packing materials for contents of small items. Retain original shipping box and packing materials. Orders may be split into multiple boxes which can be delivered on different days. Contact Speedway Motors for instructions regarding shortage claim within 5 days of receipt. Speedway Motors assumes no liability after this 5 day period.

REFUSALS All refused packages will be billed the freight to and from the destination and refused COD orders will be billed a 15% restocking charge plus freight to and from destination.

WARRANTY CLAIMS If the item is used or installed and a warranty claim request is submitted, warranty work is done by the manufacturer and may take up to 30 days for processing. Speedway Motors will be required to follow the manufacturer's warranty instructions to allow for a credit refund or exchange when specified.

RETURNS We want you to be satisfied with your purchase. If you are not satisfied, you may return your new, unused item within 60 days for refund or exchange.

All exchanged or returned merchandise must be in original factory condition with no modifications or alterations. Returned merchandise must include original packaging materials, warranty cards, manuals, instructions, etc. If the returned item requires repackaging, your refund / exchange will be subject to a repackaging charge. Return/Exchange transactions less than \$99 are excluded from the free shipping offer.

HOW TO RETURN AN ITEM Please re-pack the item in a sturdy box, include a copy of your invoice and completed return form. Returns must be shipped prepaid. CODs are not accepted. Shipping costs for exchanged merchandise will be charged to your credit card.

Items that are returned after 60 days are subject to a 15% restocking charges. Fiberglass items returned will be subject to a 15% restocking charge. We are unable to accept returns on electrical parts, video tapes, DVD's, books, special order or closeout merchandise.

BRAKE INSTALLATION ALERT The selection and installation of brake components should only be done by personnel experienced in the proper installation and operation of braking systems. The installer must use his/her own discretion to determine the suitability of all brake components and brake kits for every particular application. Speedway Motors, Inc. makes no warranties either expressed or implied including any warranty of merchantability or fitness for a particular purpose, other than those contained in its current catalog or website with respect to the goods identified on the face of the invoice. There is no warranty expressed or implied as to whether the goods sold hereby will protect the purchaser or ultimate user of such goods from injury or death.

EXHAUST INSTALLATION ALERT Exhaust systems and other component surface finishes are not permanent. Coatings, paint and other factory supplied cosmetic treatments are only intended to protect from surface corrosion in an unused state. No returns are allowed after the parts have been installed. Header flanges must be clean and clear of paint and surface contaminants prior to mating to exhaust gaskets. Exhaust fasteners must be re-torqued after the initial heat cycle and regularly thereafter to ensure a proper gasket seal is maintained. Should you decide to install this exhaust product at your home, be warned that pleasure car or light duty truck/van "bumper" jacks are intended for emergency use only. The use of frame contact jack stands in conjunction with a floor jack as a main support is highly recommended to minimize accidental dropping of a vehicle while the installation proceeds. We recommend the use of a shop hoist if possible. Please use caution! Speedway Motors, Inc. makes no warranties either expressed or implied including any warranty of merchantability or fitness for a particular purpose, other than those contain in its current catalog or website with respect to the goods identified on the face of the invoice. There is no warranty expressed or implied as to whether the goods sold hereby will protect the purchaser or ultimate user of such goods from injury or death.

CHECK LOCAL LAW Some parts are not legal for sale or use in California on any pollution controlled motor vehicles. These items are legal in California for racing vehicles only which may never be used upon a highway. Check local law.

Find the above info on our website:

SpeedwayMotors.com/Info/FAQ

© 2023, Speedway Motors, Inc.

Speedway Motors, Inc.

P.O. Box 81906 • Lincoln, NE 68501

800.979.0122 • SpeedwayMotors.com

